

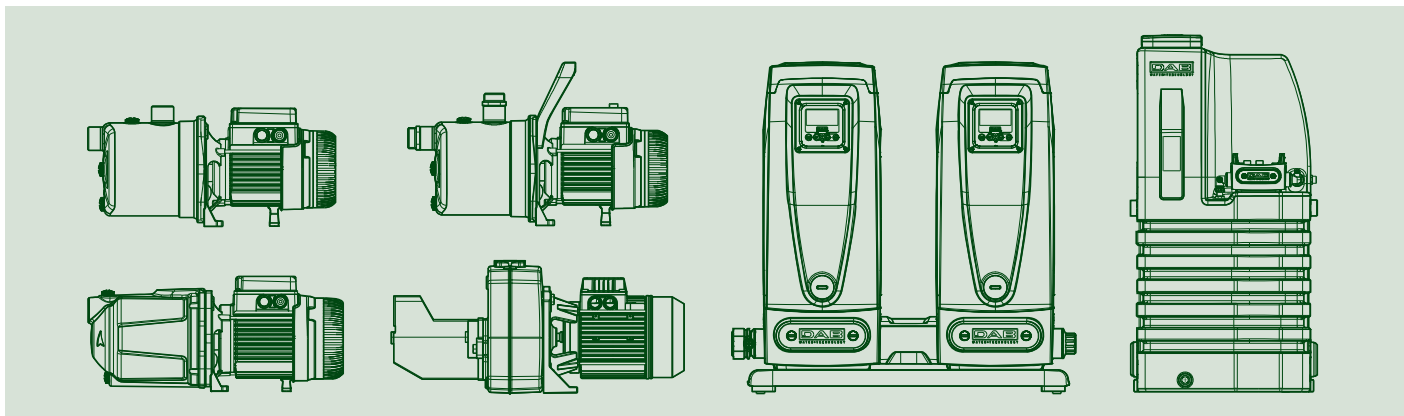

WATER • TECHNOLOGY

SELF-PRIMING MULTISTAGE CENTRIFUGAL PUMPS



TECHNICAL CATALOGUE

GARDEN INOX

SELF-PRIMING CENTRIFUGAL PUMPS



TECHNICAL DATA

Operating range:

from 0.4 to 5.4 m³/h with head up to 54 metres

Liquid quality requirements: clean, free from solid or abrasive contaminants, non-viscous, non-aggressive, uncrystallised and chemically neutral, close to the properties of water

Liquid temperature range:

from 0°C to +35°C for domestic use (EN 60335-2-41)

for other use: from 0°C to +40°C

Maximum suction depth: 8 metres

Maximum ambient temperature: +40°C

Maximum operating pressure: 8 bar (800 kPa)

6 bar (600 kPa) only for models in technopolymer (JETCOM)

Installation: fixed in a horizontal position

Special executions on request: alternative voltages and/or frequencies

Motor protection rating: IP 44

Terminal block protection rating: IP 55

Insulation class: F

Standard input voltage: single phase 220/240 V / 50 Hz

APPLICATIONS

Self-priming electric centrifugal pump for gardening, horticulture, washing and leisure activities.

Equipped with a handle to aid in transport, a H07RN-F 2 metre power cord with plug and on-off switch.

Compact, easy to install, self-priming for pumping out pools, wells, and waterways even in the presence of air bubbles. Suitable for pumping water with low levels of sandy impurities.

CONSTRUCTIONAL FEATURES OF THE PUMP

Pump body in stainless steel and motor support in die cast aluminium.

Impeller, diffuser, venturi tube in technopolymer.

Stainless steel wear ring and seal holder.

Carbon/ceramic mechanical seal.

CONSTRUCTIONAL FEATURES OF THE MOTOR

Asynchronous type, closed, with external air cooling.

Rotor mounted on oversized greased-for-life ball bearings, to guarantee low noise and long life.

Incorporated thermo-amperometric protection and permanently inserted capacitor.

Manufacture pursuant to CEI 2-3 and CEI 61-69 (EN 60335-2-41) standard.

GARDEN INOX

SELF-PRIMING CENTRIFUGAL PUMPS

MATERIALS

N°	PARTS*	MATERIALS
1	PUMP BODY	GJL 200 UNI EN 1561 CAST IRON
3	FRAME	DIE CAST ALUMINIUM
4	IMPELLER	PPO-GF 20 (Noryl™)
7	SHAFT WITH ROTOR	AISI 416 STAINLESS STEEL X12CrS13 UNI EN 10088 (UNI 6900: 71)
16	MECHANICAL SEAL	CARBON/CERAMIC
28	OR GASKET	NBR RUBBER
160	VENTURI DIFFUSER NOZZEL GROUP	PPO-GF 20 (Noryl™)

* In contact with liquid

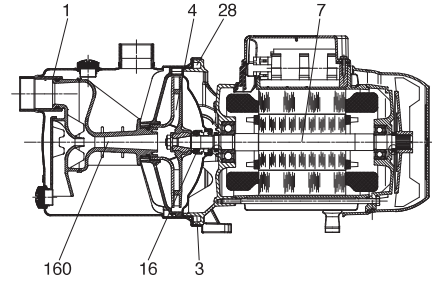

SELF PRIMING CAPACITY

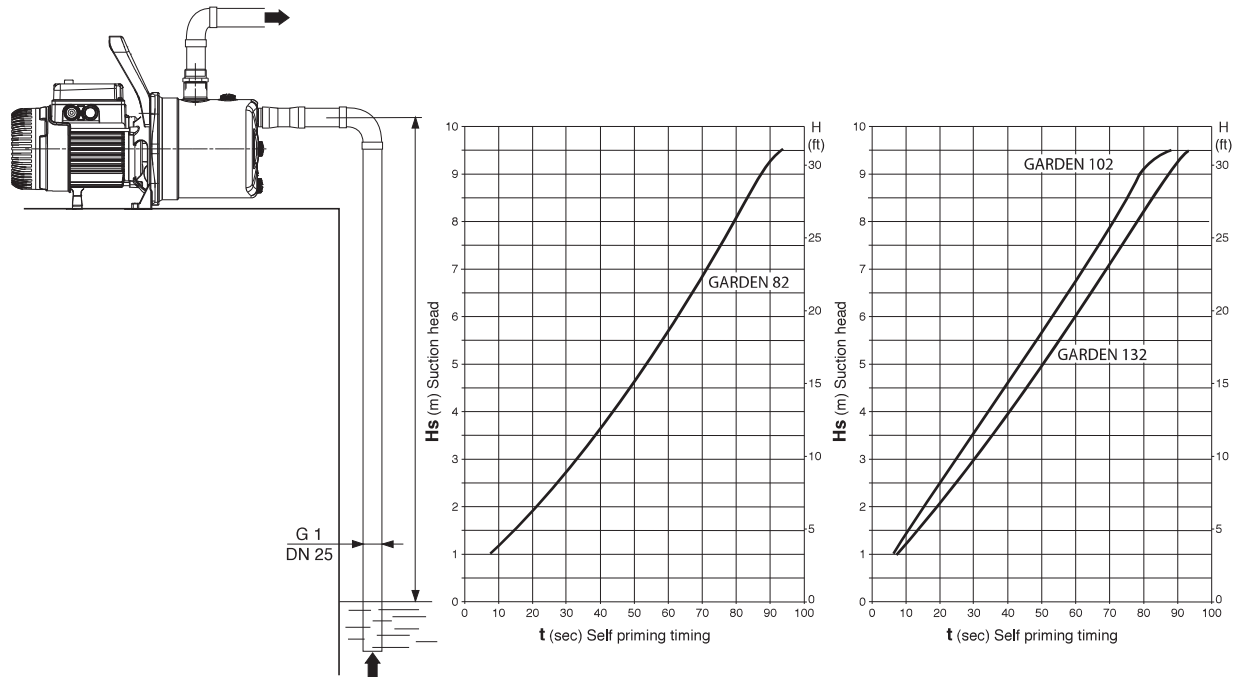

GARDEN INOX

SELF-PRIMING CENTRIFUGAL PUMPS

PERFORMANCE RANGE

The performance curves are based on kinematic viscosity values = 1 mm²/s and density equivalent to 1000 kg/m³. Curve tolerance according to ISO 9906.

GRAPHIC SELECTION TABLE

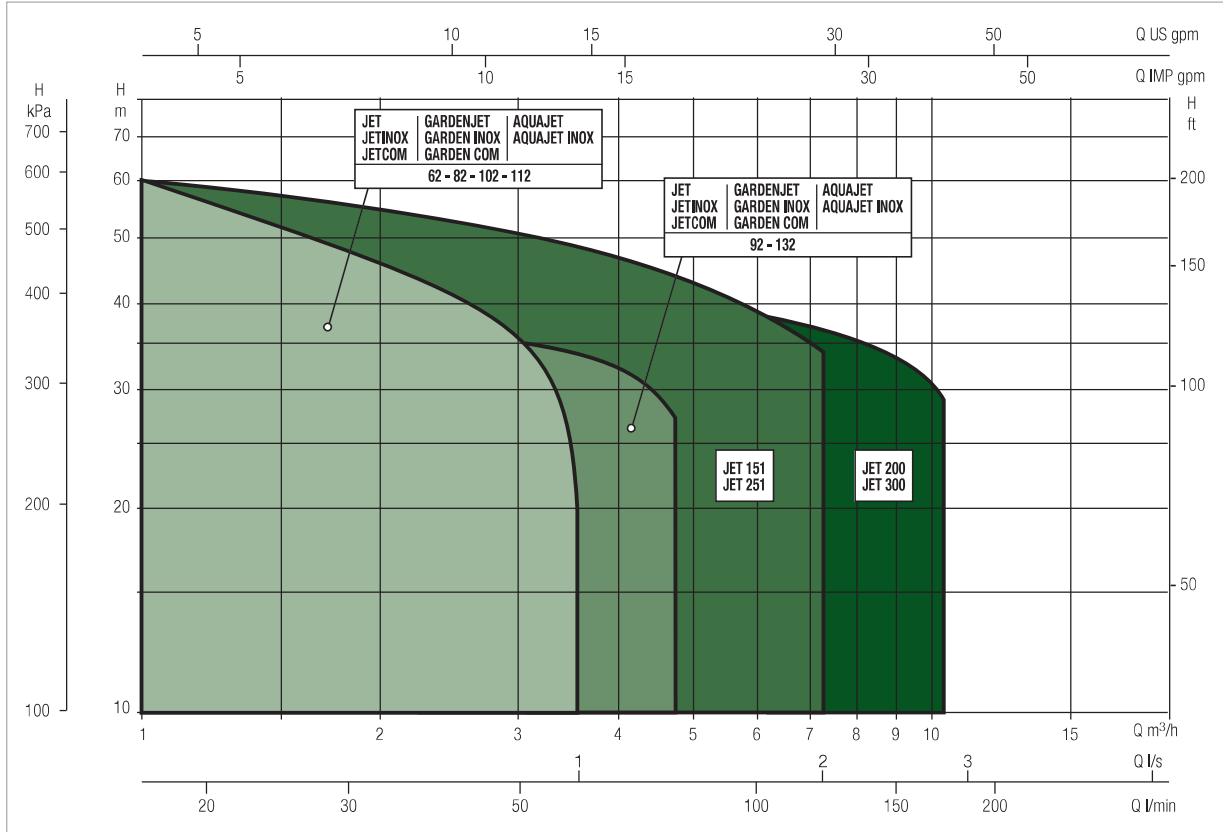

GARDEN INOX SELECTION TABLE

MODEL	Q=m ³ /h	0	0,6	1,2	1,8	2,4	3,0	3,6	4,2	4,8
	Q=l/min	0	10	20	30	40	50	60	70	80
GARDEN-INOX 82 M	H (m)	47	40	34	30	26,2	23,5	20,3		
GARDEN-INOX 102 M		53,8	47	41	36,3	32,4	28,8	25,8		
GARDEN-INOX 132 M		48,3	45,6	42,8	40	37,6	35	32,5	30	27,2

GARDEN INOX - SELF-PRIMING CENTRIFUGAL PUMPS

Liquid temperature range pumped: from 0 °C to +35 °C - Maximum ambient temperature: +40°C

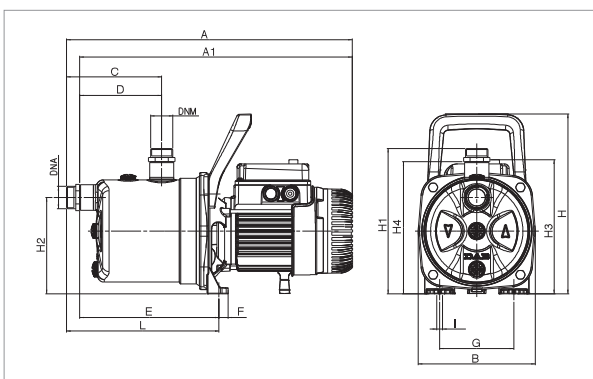
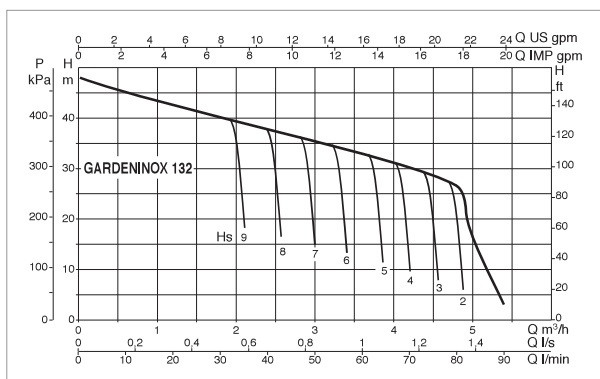
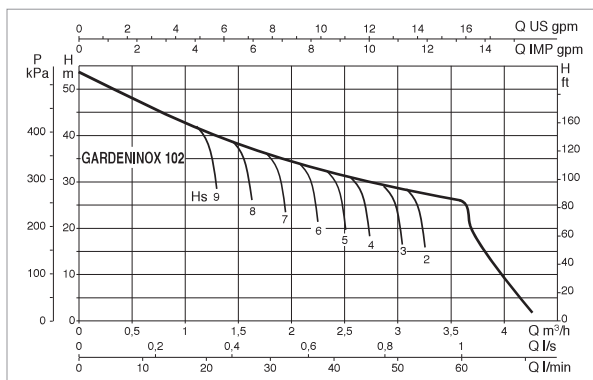
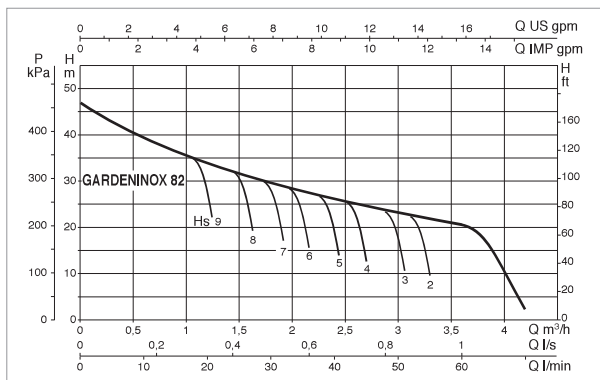

The performance curves are based on kinematic viscosity values = 1 mm²/s and density equivalent to 1000 kg/m³. Curve tolerance according to ISO 9906.

MODEL	ELECTRICAL DATA						
	POWER SUPPLY 50 Hz	P1 MAX kW	P2 NOMINAL		In A	CAPACITOR	
			kW	HP		µF	Vc
GARDEN-INOX 82 M	1x220-240 V ~	0,85	0,6	0,8	3,8	12,5	450
GARDEN-INOX 102 M	1x220-240 V ~	1,13	0,75	1	5,1	16	450
GARDEN-INOX 132 M	1x220-240 V ~	1,49	1	1,36	6,6	25	450

MODEL	A	A1	A2	B	C	D	E	F	G	H	H1	H2	H3	H4	I Ø	L	DNA GAS	DNM GAS	PACKING DIMENSIONS			VOLUME (mc)	GROSS WEIGHT Kg
	L/A	L/B	H																				
GARDEN-INOX 82 M	424	406	-	174	142	122	207	14	111	268	216	144	199	197	9	227	1"	1"	470	240	240	0,027	10,7
GARDEN-INOX 102 M	444	424	-	174	142	122	207	14	111	268	216	144	209	197	9	227	1"	1"	470	240	240	0,027	12,5
GARDEN-INOX 132 M	444	424	-	174	142	122	207	14	111	268	216	144	209	197	9	227	1"	1"	470	240	240	0,027	13,5



DAB
PUMPS SELECTOR

On-line product selection



DAB PUMPS LTD.
6 Gilberd Court
Newcomen Way
Severalls Business Park
Colchester
Essex
CO4 9WN - UK
salesuk@dwtgroup.com
Tel. +44 0333 777 5010



DAB PUMPS IBERICA S.L.
Calle Verano 18-20-22
28850 - Torrejón de Ardoz - Madrid
Spain
Info.spain@dwtgroup.com
Tel. +34 91 6569545
Fax: + 34 91 6569676



DAB PUMPS SOUTH AFRICA (PTY) LTD
Twenty One Industrial Estate,
16 Purlin Street, Unit B, Warehouse 4
Ollifantsfontein - 1666 - South Africa
info.sa@dwtgroup.com
Tel. +27 12 361 3997



DAB PUMPS BV
"Hofveld 6 C1
1702 Groot Bijgaarden - Belgium
info.belgium@dwtgroup.com
Tel. +32 2 4668353



DAB PUMPS HUNGARY KFT.
H-8800
Nagykanizsa, Buda Ernő u.5
Hungary
Tel. +36 93501700



DAB PUMPS (QINGDAO) CO, LTD.
No.40 Kaituo Road, Qingdao Economic & Technological
Development Zone
Qingdao City, Shandong Province - China
PC: 266500
sales.cn@dwtgroup.com
Tel. +86 400 186 8280
Fax +86 53286812210



DAB PUMPS B.V.
Albert Einsteinweg, 4
5151 DL Drunen - Nederland
info.netherlands@dwtgroup.com
Tel. +31 416 387280
Fax +31 416 387299



DAB PUMPS POLAND Sp. z o.o.
Ul. Janka Muzykanta 60
02-188 Warszawa - Poland
polska@dabpumps.com.pl



DAB PUMPS DE MÉXICO, S.A. DE C.V.
Av Amsterdam 101 Local 4
Col. Hipódromo Condesa,
Del. Cuauhtémoc CP 06170
Ciudad de México
Tel. +52 55 6719 0493



OOO DAB PUMPS
Novgorodskaya str. 1, block G
office 308, 127247, Moscow - Russia
info.russia@dwtgroup.com
Tel. +7 495 122 0035
Fax +7 495 122 0036



DAB PUMPS OCEANIA PTY LTD
426 South Gippsland Hwy,
Dandenong South VIC 3175 - Australia
info.oceania@dwtgroup.com
Tel. +61 1300 373 677



DAB PUMPS GMBH
Am Nordpark 3
D - 41069 Mönchengladbach - Germany
info.germany@dwtgroup.com
Tel. +49 2161 47388-0
Fax +49 2161 47388-36



DAB PUMPS INC.
3226 Benchmark Drive
Ladson, SC 29456 - USA
info.usa@dwtgroup.com
Tel. 1- 843-797-5002
Fax 1-843-797-3366



PT DAB PUMPS INDONESIA
Satrio Tower lantai 26
unit C-D, Jl. Prof. Dr. Satrio Kav. C4,
Kel. Kuningan Timur, Kec. Setiabudi, Kota Adm.
Jakarta Selatan, Prov. DKI Jakarta. - Indonesia
Tel. +62 2129222850